

## LAYHER ROLSTEIGER BOUWVORMEN

### KOMBI 180X75

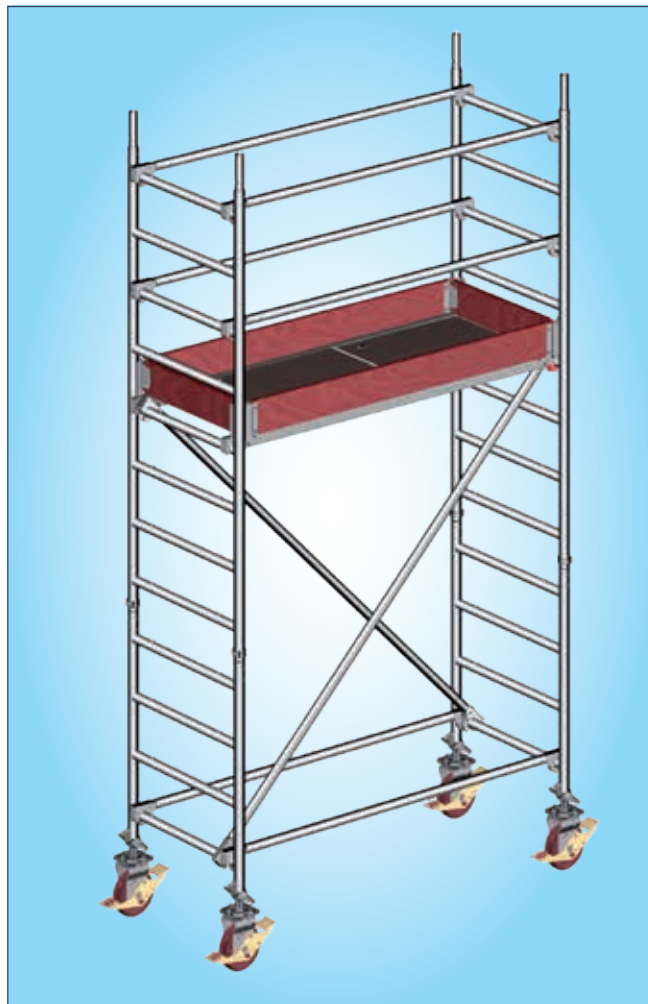

#### Bouwhoogtes

Comform NEN-EN 1004  
EU richtlijnen 2001/45/EG  
en  
Arbo Informatieblad-21

Uitgave 04.2018  
DOC0107



## KOMBI 180 X 75

Om te voldoen aan de eisen voor een veilige (de)montage van rolsteigers heeft Layher de montagemethode P2 ontwikkeld:

- ▶ Gebruik van speciaal ontwikkelde (P2) montagehaken
- ▶ Platformen op iedere 2m
- ▶ Veilige opbouw d.m.v. voorloopleuning



Met platformen op iedere 2m en het gebruik van de P2 montagehaken kunnen de standelementen met de heupleuning al vanaf een lager niveau aangebracht worden. Bij het betreden van het bovenliggende platform is men dus verzekerd van een zijdelingse bescherming rondom. Raadpleeg de uitgebreide P2 Montagehandleiding.

### P2 Rolsteigermontagehaak (2 stuks)

Artikelnr. 1300/001 1.20 kg. 2 ex.



P2 montagehaken

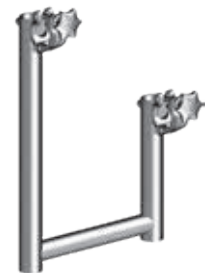

Opstapbeugel 0.30m

### Aluminium opstapbeugel Uni 0.30m

Artikelnr. 1344/002 2.90 kg.

De P2 montagemethode kan toegepast worden bij de Uni 285mm x 75mm, de Uni 285mm x 150mm, de Kombi 180mm x 75mm en de Kombi 180mm x 150mm.

Heeft u al een Layher rolsteiger dan kunt u deze aanvullen tot P2 rolsteiger.

### Ballasttabel rolsteigers voor gebruik tot en met 6 Beaufort:

#### KOMBI 180 x 75:

Bouwworm	03	04	05	06	07	08	09	10	11
Binnengebruik	0	0	2	2	6	8	10	12	14
Buitengebruik	2	2	8	12	20				

 = Binnengebruik

 = Buitengebruik

 = Niet van toepassing

### Codering: EN 1004 3 - / x x x D

Het aanbrengen van de ballast gebeurt, voor deze rolsteigers, altijd overhoeks (tegenovergestelde hoeken) zodat het zwaartepunt in het midden ligt. Zo laag mogelijk (basis standelement) aan de verticale buizen.

### Rolsteigerballast



Artikelnr. 1249/000 10 kg.



## KOMBI 180 X 75

**Bouwworm 01**  
**3 - 1.50\* / 0.00**  
**Steigerhoogte 2.70m**



<b>Werkhoogte (m)</b>		<b>3.50</b>
<b>Steigerhoogte (m)</b>		<b>2.70</b>
<b>Stahoogte (m)</b>		<b>1.50</b>

Artikelnr.	Omschrijving	Gew. kg	Aantal	Totaal kg
1259/201	Zwenkwiel T11 ø200mm 700kg	6.7	4	26.8
1297/008	Alu standelement 75 8 sporten	8.6	2	17.2
1241/180	Alu platform 1.80m	13.3	1	13.3
1206/180	Alu dubbele leuning 1.80m	5,8	2	11.6
<b>Totaal</b>				<b>68.9</b>



\*) Deze steigers voor binnengebruik vallen niet onder de EN 1004 richtlijnen (vloer-/stahoogte < 2.50m) en niet onder de VGS-certificatie.

Totale belasting met werkvloerbelasting: 2,9 kN 0,7 kN per wiel

## KOMBI 180 X 75

**Bouwworm 02**  
**3 - 2.40 \* / 0.00**  
**Steigerhoogte 3.70m**



<b>Werkhoogte (m)</b>		<b>4.40</b>
<b>Steigerhoogte (m)</b>		<b>3.70</b>
<b>Stahoogte (m)</b>		<b>2.40</b>

Artikelnr.	Omschrijving	Gew. kg	Aantal	Totaal kg
1259/201	Zwenkwiel T11 ø200mm 700kg	6.7	4	26.8
1297/008	Alu standelement 75 8 sporten	8.6	2	17.2
1297/004	Alu standelement 75 4 sporten	4.7	2	9.4
1205/180	Alu ligger 1.80m	2.3	6	13.8
1208/180	Alu diagonaal Kombi 1.75x1.80m	3.3	2	6.6
1242/180	Alu platform met luik 1.80m	15.0	1	15.0
1239/180	Kantplank 1.80m	3.9	2	7.8
1238/075	Kopkantplank 0.75m	1.3	2	2.6
4000/001	Borgpen	0.1	4	0.4
<b>Totaal</b>			<b>99.6</b>	

1300/001	P2 Montagehaken (per set)		1	1.2
----------	---------------------------	--	---	-----

**\*) Deze steigers voor binnengebruik vallen niet onder de EN 1004 richtlijnen (vloer-/stahoogte < 2.50m) en niet onder de VGS-certificatie.**

Totale belasting met werkvloerbelasting: 3,2 kN 0,8 kN per wiel







## KOMBI 180 X 75

### Bouwworm 03

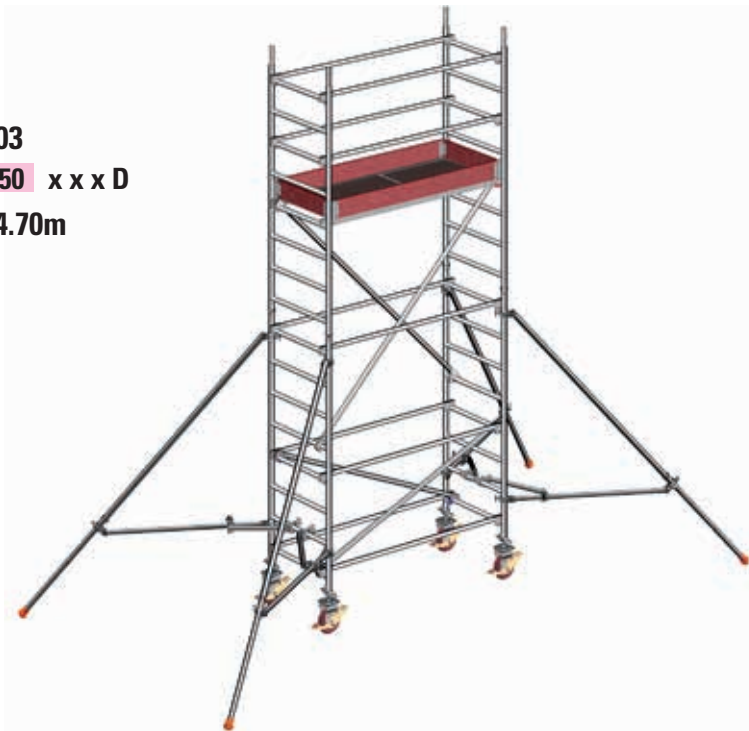
EN 1004 - 3 - 3.50 / 3.50 x x x D

Steigerhoogte 4.70m



<b>Werkhoogte (m)</b>		<b>5.50</b>
<b>Steigerhoogte (m)</b>		<b>4.70</b>
<b>Stahoogte (m)</b>		<b>3.50</b>



Artikelnr.	Omschrijving	Gew. kg	Aantal	Totaal kg
1259/201	Zwenkwiel T11 ø200mm 700kg	6.7	4	26.8
1297/008	Alu standelement 75 8 sporten	8.6	4	34.4
1205/180	Alu ligger 1.80m	2.3	10	23.0
1208/180	Alu diagonaal Kombi 1.75x1.80m	3.3	2	6.6
1208/195	Alu diagonaal Kombi 0.75x1.80m	2.8	2	5.6
1242/180	Alu platform met luik 1.80m	15.0	1	15.0
1239/180	Kantplank 1.80m	3.9	2	7.8
1238/075	Kopkantplank 0.75m	1.3	2	2.6
1248/260	Zijsteun vouwbaar/verstelbaar 2.6m	8.5	4	34.0
1248/261	Verdraai beveiliging 0.50m	2.8	4	11.2
4000/001	Borgpen	0.1	4	0.4
<b>Totaal</b>				<b>167.4</b>
1249/000	Rolsteigerballast (Binnengebruik)	10.0	0	00.0
1249/000	Rolsteigerballast (Buitengebruik)	10.0	2	20.0
1300/001	P2 Montagehaken (per set)		1	1.2

Totale belasting met werkvloerbelasting:	3,9 kN	1,0 kN per wiel
Totale belasting met werkvloerbelasting:	4,1 kN	1,0 kN per wiel

## KOMBI 180 X 75

**Bouwworm 04**  
**EN 1004 - 3 - 4.50 / 4.50 x x x D**  
**Steigerhoogte 5.70m**



<b>Werkhoogte (m)</b>		<b>6.50</b>
<b>Steigerhoogte (m)</b>		<b>5.70</b>
<b>Stahoogte (m)</b>		<b>4.50</b>



Artikelnr.	Omschrijving	Gew. kg	Aantal	Totaal kg
1259/201	Zwenkwiel T11 ø200mm 700kg	6.7	4	26.8
1297/008	Alu standelement 75 8 sporten	8.6	4	34.4
1297/004	Alu standelement 75 4 sporten	4.7	2	9.4
1205/180	Alu ligger 1.80m	2.3	10	23.0
1208/180	Alu diagonaal Kombi 1.75x1.80m	3.3	4	13.2
1242/180	Alu platform met luik 1.80m	15.0	2	30.0
1239/180	Kantplank 1.80m	3.9	2	7.8
1238/075	Kopkantplank 0.75m	1.3	2	2.6
1248/260	Zijsteun vouwbaar/verstelbaar 2.6m	8.5	4	34.0
1248/261	Verdraai beveiliging 0.50m	2.8	4	11.2
4000/001	Borgpen	0.1	8	0.8
<b>Totaal</b>			<b>193.2</b>	
1249/000	Rolsteigerballast (Binnengebruik)	10.0	0	00.0
1249/000	Rolsteigerballast (Buitengebruik)	10.0	2	20.0
1300/001	P2 Montagehaken (per set)		1	1.2

Totale belasting met werkvloerbelasting:	5,3 kN	1,3 kN per wiel
Totale belasting met werkvloerbelasting:	5,5 kN	1,4 kN per wiel

## KOMBI 180 X 75

**Bouwworm 05**  
**EN 1004 - 3 - 5.50 / 5.50 x x x D**  
**Steigerhoogte 6.70m**



<b>Werkhoogte (m)</b>		<b>7.50</b>
<b>Steigerhoogte (m)</b>		<b>6.70</b>
<b>Stahoogte (m)</b>		<b>5.50</b>

Artikelnr.	Omschrijving	Gew. kg	Aantal	Totaal kg
1259/201	Zwenkwiel T11 ø200mm 700kg	6.7	4	26.8
1297/008	Alu standelement 75 8 sporten	8.6	6	51.6
1205/180	Alu ligger 1.80m	2.3	14	32.2
1208/180	Alu diagonaal Kombi 1.75x1.80m	3.3	4	13.2
1208/195	Alu diagonaal Kombi 0.75x1.80m	2.8	2	5.6
1242/180	Alu platform met luik 1.80m	15.0	2	30.0
1239/180	Kantplank 1.80m	3.9	2	7.8
1238/075	Kopkantplank 0.75m	1.3	2	2.6
1248/260	Zijsteun vouwbaar/verstelbaar 2.6m	8.5	4	34.0
1248/261	Verdraai beveiliging 0.50m	2.8	4	11.2
4000/001	Borgpen	0.1	8	0.8
<b>Totaal</b>				<b>215.8</b>
1249/000	Rolsteigerballast (Binnengebruik)	10.0	2	20.0
1249/000	Rolsteigerballast (Buitengebruik)	10.0	8	80.0
1300/001	P2 Montagehaken (per set)		1	1.2



Totale belasting met werkvloerbelasting:	5,7 kN	1,4 kN per wiel
Totale belasting met werkvloerbelasting:	6,3 kN	1,6 kN per wiel

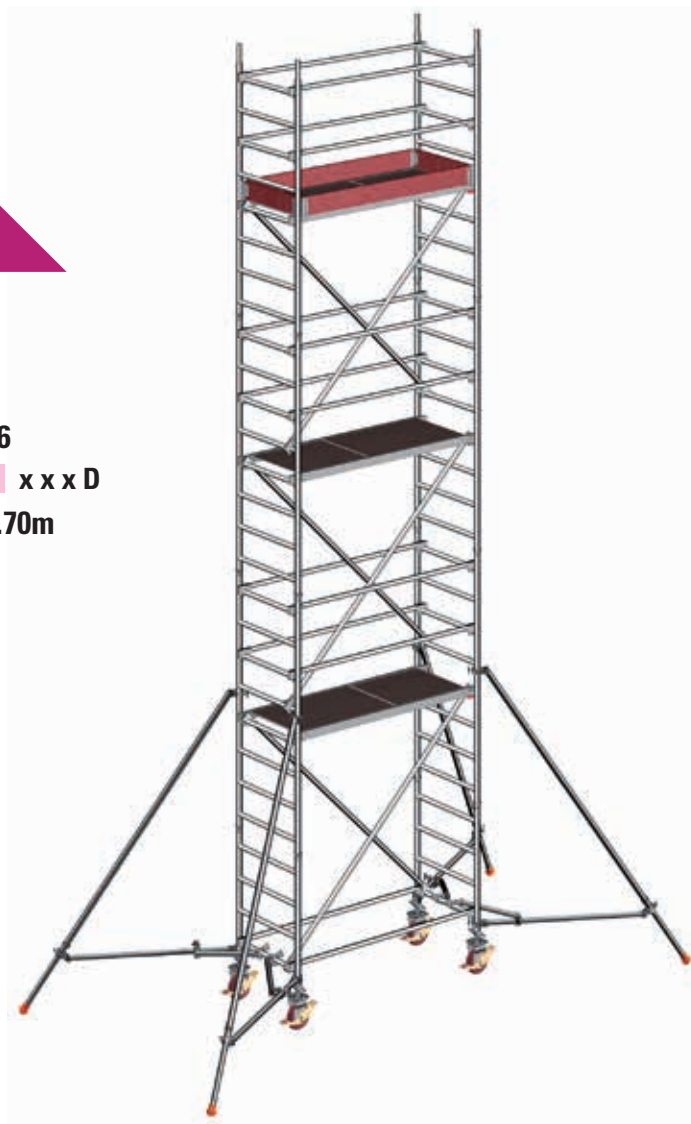

## KOMBI 180 X 75

**Bouwworm 06**  
**EN 1004 - 3 - 6.50 / 6.50 x x x D**  
**Steigerhoogte 7.70m**



<b>Werkhoogte (m)</b>		<b>8.50</b>
<b>Steigerhoogte (m)</b>		<b>7.70</b>
<b>Stahoogte (m)</b>		<b>6.50</b>

Artikelnr.	Omschrijving	Gew. kg	Aantal	Totaal kg
1259/201	Zwenkwiel T11 ø200mm 700kg	6.7	4	26.8
1297/008	Alu standelement 75 8 sporten	8.6	6	51.6
1297/004	Alu standelement 75 4 sporten	4.7	2	9.4
1205/180	Alu ligger 1.80m	2.3	14	32.2
1208/180	Alu diagonaal Kombi 1.75x1.80m	3.3	6	19.8
1242/180	Alu platform met luik 1.80m	15.0	3	45.0
1239/180	Kantplank 1.80m	3.9	2	7.8
1238/075	Kopkantplank 0.75m	1.3	2	2.6
1248/260	Zijsteun vouwbaar/verstelbaar 2.6m	8.5	4	34.0
1248/261	Verdraai beveiliging 0.50m	2.8	4	11.2
4000/001	Borgpen	0.1	12	1.2
<b>Totaal</b>			<b>241.6</b>	
1249/000	Rolsteigerballast (Binnengebruik)	10.0	2	20.0
1249/000	Rolsteigerballast (Buitengebruik)	10.0	12	120.0
1300/001	P2 Montagehaken (per set)		1	1.2



Totale belasting met werkvloerbelasting:	6,0 kN	1,5 kN per wiel
Totale belasting met werkvloerbelasting:	7,0 kN	1,7 kN per wiel



## KOMBI 180 X 75

**Bouwworm 07**  
**EN 1004 - 3 - 7.50 / 7.50 x x x D**  
**Steigerhoogte 8.70m**



<b>Werkhoogte (m)</b>		<b>9.50</b>
<b>Steigerhoogte (m)</b>		<b>8.70</b>
<b>Stahoogte (m)</b>		<b>7.50</b>



Artikelnr.	Omschrijving	Gew. kg	Aantal	Totaal kg
1259/201	Zwenkwiel T11 ø200mm 700kg	6.7	4	26.8
1297/008	Alu standelement 75 8 sporten	8.6	8	68.8
1205/180	Alu ligger 1.80m	2.3	18	41.4
1208/180	Alu diagonaal Kombi 1.75x1.80m	3.3	6	19.8
1208/195	Alu diagonaal Kombi 0.75x1.80m	2.8	2	5.6
1242/180	Alu platform met luik 1.80m	15.0	3	45.0
1239/180	Kantplank 1.80m	3.9	2	7.8
1238/075	Kopkantplank 0.75m	1.3	2	2.6
1248/260	Zijsteun vouwbaar/verstelbaar 2.6m	8.5	4	34.0
1248/261	Verdraai beveiliging 0.50m	2.8	4	11.2
4000/001	Borgpen	0.1	12	1.2
<b>Totaal</b>				<b>264.2</b>
1249/000	Rolsteigerballast (Binnengebruik)	10.0	6	60.0
1249/000	Rolsteigerballast (Buitengebruik)	10.0	20	200.0
1300/001	P2 Montagehaken (per set)		1	1.2

Totale belasting met werkvloerbelasting:	6,6 kN	1,6 kN per wiel
Totale belasting met werkvloerbelasting:	8,0 kN	2,0 kN per wiel

## KOMBI 180 X 75

**Bouwworm 08**  
**EN 1004 - 3 - 8.50 / x.xx x x x D**  
**Steigerhoogte 9.70m**



<b>Werkhoogte (m)</b>		<b>10.50</b>
<b>Steigerhoogte (m)</b>		<b>9.70</b>
<b>Stahoogte (m)</b>		<b>8.50</b>

Artikelnr.	Omschrijving	Gew. kg	Aantal	Totaal kg
1259/201	Zwenkwiel T11 ø200mm 700kg	6.7	4	26.8
1297/008	Alu standelement 75 8 sporten	8.6	8	68.8
1297/004	Alu standelement 75 4 sporten	4.7	2	9.4
1205/180	Alu ligger 1.80m	2.3	18	41.4
1208/180	Alu diagonaal Kombi 1.75x1.80m	4.0	8	32.0
1242/180	Alu platform met luik 1.80m	15.0	4	60.0
1239/180	Kantplank 1.80m	3.9	2	7.8
1238/075	Kopkantplank 0.75m	1.3	2	2.6
1248/260	Zijsteun vouwbaar/verstelbaar 2.6m	8.5	4	34.0
1248/261	Verdraai beveiliging 0.50m	2.8	4	11.2
4000/001	Borgpen	0.1	16	1.6
<b>Totaal</b>				<b>295.6</b>
1249/000	Rolsteigerballast (Binnengebruik)	10.0	8	80.0
1300/001	P2 Montagehaken (per set)		1	1.2

Totale belasting met werkvloerbelasting: 7,1 kN | 1,8 kN per wiel



## KOMBI 180 X 75

### Bouwworm 09

EN 1004 - 3 - 9.50 / x.xx x x x D

Steigerhoogte 10.70m



<b>Werkhoogte (m)</b>		<b>11.50</b>
<b>Steigerhoogte (m)</b>		<b>10.70</b>
<b>Stahoogte (m)</b>		<b>9.50</b>



Artikelnr.	Omschrijving	Gew. kg	Aantal	Totaal kg
1259/201	Zwenkwiel T11 ø200mm 700kg	6.7	4	26.8
1297/008	Alu standelement 75 8 sporten	8.6	10	86.0
1205/180	Alu ligger 1.80m	2.3	22	50.6
1208/180	Alu diagonaal Kombi 1.75x1.80m	3.3	6	19.8
1208/195	Alu diagonaal Kombi 0.75x1.80m	2.8	2	5.6
1242/180	Alu platform met luik 1.80m	15.0	4	60.0
1239/180	Kantplank 1.80m	3.9	2	7.8
1238/075	Kopkantplank 0.75m	1.3	2	2.6
1248/260	Zijsteun vouwbaar/verstelbaar 2.6m	8.5	4	34.0
1248/261	Verdraai beveiliging 0.50m	2.8	4	11.2
4000/001	Borgpen	0.1	16	1.6
<b>Totaal</b>				<b>306.0</b>
1249/000	Rolsteigerballast (Binnengebruik)	10.0	10	100.0
1300/001	P2 Montagehaken (per set)		1	1.2

Totale belasting met werkvloerbelasting: 7,4 kN | 1,9 kN per wiel

## KOMBI 180 X 75

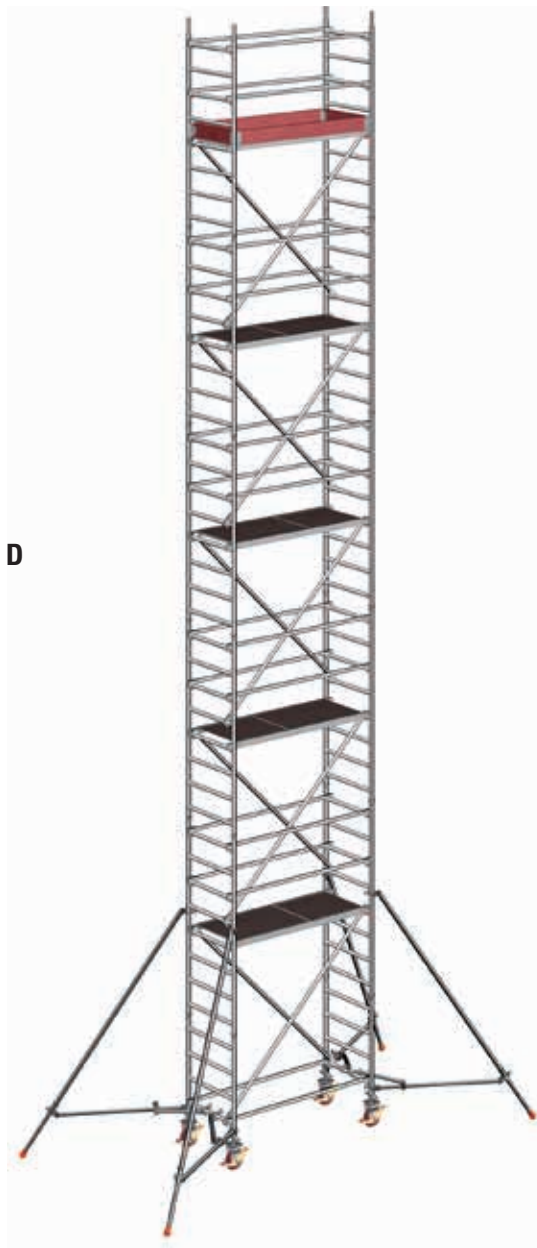
**Bouwworm 10**  
**EN 1004 - 3 - 10.50 / xx.x x x x D**  
**Steigerhoogte 11.70m**



<b>Werkhoogte (m)</b>		<b>12.50</b>
<b>Steigerhoogte (m)</b>		<b>11.70</b>
<b>Stahoogte (m)</b>		<b>10.50</b>



Artikelnr.	Omschrijving	Gew. kg	Aantal	Totaal kg
1259/201	Zwenkwiel T11 ø200mm 700kg	6.7	4	26.8
1297/008	Alu standelement 75 8 sporten	8.6	10	86.0
1297/004	Alu standelement 75 4 sporten	4.7	2	9.4
1205/180	Alu ligger 1.80m	2.3	22	50.6
1208/180	Alu diagonaal Kombi 1.75x1.80m	3.3	10	33.0
1242/180	Alu platform met luik 1.80m	15.0	5	75.0
1239/180	Kantplank 1.80m	4.5	2	9.0
1238/075	Kopkantplank 0.75m	1.7	2	3.4
1248/260	Zijsteun vouwbaar/verstelbaar 2.6m	8.5	4	34.0
1248/261	Verdraai beveiliging 0.50m	2.8	4	11.2
4000/001	Borgpen	0.1	20	2.0
<b>Totaal</b>				<b>340.4</b>
1249/000	Rolsteigerballast (Binnengebruik)	10.0	12	120.0
1300/001	P2 Montagehaken (per set)		1	1.2

Totale belasting met werkvloerbelasting: 7,8 kN | 1,9 kN per wiel

## KOMBI 180 X 75

**Bouwworm 11**  
**EN 1004 - 3 - 11.50 / xx.x x x x D**  
**Steigerhoogte 12.70m**



<b>Werkhoogte (m)</b>		<b>13.50</b>
<b>Steigerhoogte (m)</b>		<b>12.70</b>
<b>Stahoogte (m)</b>		<b>11.50</b>

Artikelnr.	Omschrijving	Gew. kg	Aantal	Totaal kg
1259/201	Zwenkwiel T11 ø200mm 700kg	6.7	4	26.8
1297/008	Alu standelement 75 8 sporten	8.6	12	103.2
1205/180	Alu ligger 1.80m	2.3	26	59.8
1208/180	Alu diagonaal Kombi 1.75x1.80m	3.3	10	33.0
1208/195	Alu diagonaal Kombi 0.75x1.80m	2.8	2	5.6
1242/180	Alu platform met luik 1.80m	15.0	5	75.0
1239/180	Kantplank 1.80m	4.5	2	9.0
1238/075	Kopkantplank 0.75m	1.7	2	3.4
1248/260	Zijsteun vouwbaar/verstelbaar 2.6m	8.5	4	34.0
1248/261	Verdraai beveiliging 0.50m	2.8	4	11.2
4000/001	Borgpen	0.1	20	2.0
<b>Totaal</b>				<b>363.0</b>
1249/000	Rolsteigerballast (Binnengebruik)	10.0	14	140.0
1300/001	P2 Montagehaken (per set)		1	1.2

Totale belasting met werkvloerbelasting: 8,4 kN | 2,1 kN per wiel

	<b>Blitz steigersysteem</b>
	<b>Allround steigersysteem</b>
	<b>Accessoires</b>
	<b>Dak- en wand-afscherming</b>
	<b>Ondersteuning</b>
	<b>Eventsystemen</b>
	<b>Rolsteigers</b>
	<b>Ladders en trappen</b>